

Model 0607-0000 Optical Encoder

Model 1004-0000 Counter Display

The Model 0607-0000 Encoder and Model 1004-0000 Display system provides precision feedback and read-out of shaft angular displacement over the full 360° revolution. From a fixed or user settable point, angular position is displayed in degrees over indefinite shaft revolutions at speeds up to 3000 RPM, with equivalent BCD output. In simplest mode, Encoder position is displayed in increments of 0.05° over the range 0.00° to 359.95°. Display and Encoder are sold separately and will deliver full accuracy without adjustment.



KEY FEATURES

- Displays Full 360° Working Range
- 0.025° Accuracy and 0.05° Resolution
- Speeds to 3,000 RPM
- Binary-Coded-Decimal (BCD) Output

Model 0607-0000 Encoder

Model 0607-0000 is a rotary, incremental Encoder that outputs 1800 cycles of quadrature TTL signal and one zero reference pulse (Z_R) per shaft revolution. Compact size, low weight, and servo and/or bolt-face mounting make it easy to install, even where space is limited.

The Encoder's precision pilot diameter provides a reference for mounting the unit concentric to the shaft to be monitored. Four tapped holes in the face, or the servo slot on its circumference, provide two means for securing the body to the user's reference surface. Installation of a flexible shaft coupling (see *Accessories* section, pg. 4) is highly recommended to protect the Encoder from excessive misalignment or motion of the monitored shaft. Encoder cable can be soldered directly to the Display connector or can be extended (see *Accessories* section, pg. 4).

Model 1004-0000 Display Counter

Model 1004-0000 is a panel mount, 5-digit LED Display that excites the Encoder, decodes its output into 7200 counts/revolution, and displays the shaft angle position - in increments of 0.05° - from the last reset. It also provides latchable, parallel BCD output that matches the displayed value. When tri-state enabled, the BCD output can be used as an 8-bit parallel, word serial, multiplexed signal for input into an 8-bit port.

The compact 1/8 DIN case, rear-panel set-up, and solder termination make it easy to install, even where space is limited. The Display installs directly through panels up to 0.20 inch (5.1 mm) thick, or can be used as a benchtop instrument. All necessary mating edge-type connectors are included, to which Encoder leads, 5 VDC power and any other required connections can be soldered directly (see *Accessories* section for appropriate Line Powered Supplies, pg. 4).

The base unit is available as Model 1004-00000. Unit with analog output option, adjustable to ± 5.0 VDC over the range $\pm 359.95^\circ$, is available as Model 1004-00001.

上海江晶翔电子有限公司

Operation of Encoder/Display System

When installed, the Encoder body is typically secured to the reference surface and its shaft is fixed (preferably by a flexible coupling) to the shaft being monitored. Its leads are connected to the Display, which requires a 5 VDC external power source that can provide at least 450 mA of current. The Display can be programmed, either locally or remotely, by electrically shorting the proper pins (ref. jumpers F1, F2, etc.) at its connector. The Display reads directly in degrees and resets to 000.00° at each of the following: 1) at power-up; 2) anytime it reaches 360.00° (regardless of sign); 3) when the front panel RESET button is pressed;

4) when F1 is closed for at least 0.01 seconds; and 5) at Z_R , only when F2 is closed. The Display is shipped with the following contacts open: F1, F2, F3, F4A and F4B. In this configuration, the display range is -359.95° to +359.95° and the displayed value increases while rotating the shaft in a *clockwise* direction (as viewed from the end of the shaft, looking towards the body). Closing F2 enables the reset at Z_R . Closing F3 changes the sense of the display to *counterclockwise*. Closing both F4A and F4B changes the display range to 000.00° to 359.95°.

Encoder Specifications

ELECTRICAL

Resolution Range	1800 cycles per revolution (7200 counts per revolution with external 4X counting when using A and B channel outputs)
Light Source	LED rated for 100,000 hours MTBF
Light Sensor	Photodiode
Excitation	5 VDC \pm 5%, 250 mA maximum
Output Format	Two count channel outputs (A and B) in phase quadrature, plus zero reference Z_R ; all are TTL single ended square waves with rise and fall time of one microsecond maximum into 1,000 pF load
Z_R Reference	Full cycle
Frequency Response	Up to 100 kHz, all channels
Phase Sense	Channel A leads B for CW rotation of shaft (as viewed from shaft end, looking towards body)
Termination	Shielded cable with #26 AWG lead wires (see diagram below for lead color vs. function)

MECHANICAL

Shaft Loading	10 lb axially and radially, maximum; 100,000 radians/sec ² maximum angular acceleration
Shaft Radial Runout	0.001 inch (.025mm) T.I.R.
Bearing	R-4 shielded; 0.1 ounce-inch (7.2 gram-cm) maximum starting torque at 25°C
Operating Speed	3000 RPM maximum continuous
Materials	303 stainless steel shaft and pilot diameter; black plastic base and cover
Weight	4 ounces (114 grams)

ENVIRONMENTAL

Temperature	32°F to 158°F (0°C to 70°C) Operating -13°F to 194°F (-25°C to 90°C) Storage
Shock	50 G's for 11 milliseconds maximum
Vibration	20 Hz to 2000 Hz at 5G's maximum
Humidity	To 98% R.H. (non-condensing)

Dimensional Diagram - Encoder

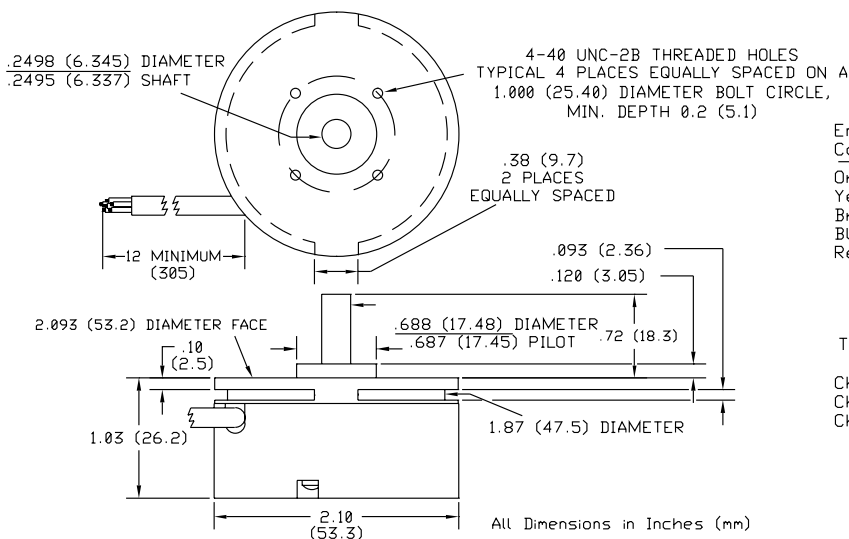

Encoder Color	Lead Color vs. Function
Orange	Channel A Output
Yellow	Channel B Output
Brown	Channel Z_R Output
Black	Common
Red	+5 VDC Input Power

Timing Diagram for CW Rotation

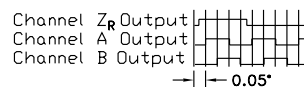

上海江晶翔电子有限公司

Display Counter Specifications

ELECTRICAL		MECHANICAL	
Resolution Range	0.05 count over range -359.95 to +359.95	Size	1/8 DIN plastic case mounts through panel up to 0.20 inch (5.1 mm) thick (see diagram below)
Display Type	0.55 inch (14 mm) high red LEDs; 5 digits plus ± sign and decimal point	Termination	Two rear panel 30-pin edge connectors with solder lugs
Excitation	5 VDC ±10%, 450 mA maximum (includes up to 250 mA to power encoder)	ENVIRONMENTAL	
Signal Inputs	Accepts TTL level single-ended A, B, Z _R inputs or complementary A*, B*, Z _R , Z _R * inputs; with A and B, or A, A*, and B, B* inputs, input count is multiplied by four; the inputs pass through a single pole noise filter rolled off at 100 kHz	Temperature	32°F to 158°F (0°C to 70°C) Operating -13°F to 194°F (-25°C to 90°C) Storage
Output Signal	Latchable, TTL BCD outputs that correspond to the displayed value; also usable as full parallel 19-bit output (or, when logic is tri state enabled, as an 8-bit parallel word, serial multiplexed output)	Shock	50 G's for 11 milliseconds maximum
Selectable Set-up Features	Closing F1 resets display to 000.00 Closing F2 enables reset at Z _R Closing F3 changes sense to CCW Closing F4/A/B selects range 000.00 - 359.95	Vibration	20 Hz to 2000 Hz at 5G's maximum
Optional Analog Output	Order as Model 1004-00001 (or without analog output option as 1004-00000)	Humidity	To 98% R.H. (non-condensing)
Voltage Output	±5.0 VDC over ±359.95°	Current Draw	5 mA maximum
Accuracy	±0.1% over 77°F ±18°F (25°C ±10°C)	Short Circuit Protection	Indefinitely

Dimensional Diagram - Display Counter

PANEL CUTOUT: 3.65 (92.7) WIDE, 1.77 (45.0) HIGH

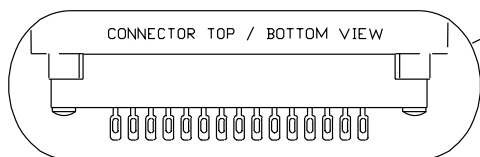
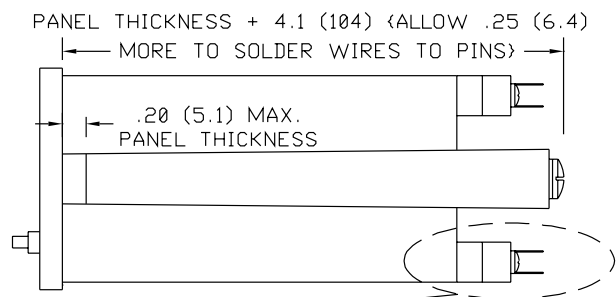
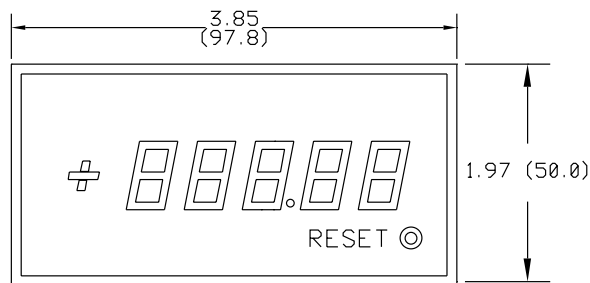

All Dimensions in Inches (mm)

Display Closure (pin/pin) vs. Function

F1 (Jx-xx/Jx-xx)	Resets display to 000.00
F2 (Jx-xx/Jx-xx)	Enables Z _R
F3 (Jx-xx/Jx-xx)	Changes sense to CCW
F4 (A=Jx-xx/Jx-xx) (B=Jx-xx/Jx-xx)	Selects range 000.00 to 359.95

Lower Connector J-1			
Pin #	Function	Pin#	Function
1	Digit 1, Bit 8	A	Digit 1, Bit 4
2	Digit 1, Bit 1	B	Digit 1, Bit 2
3	Digit 2, Bit 4	C	Digit 2, Bit 8
4	Digit 2, Bit 1	D	Digit 2, Bit 2
5	Digit 1, Digit 2 Output Disable	E	Digit 3, Digit 4 Disable
6	BCD Latch (Low Latches)	F	Digit 3, Bit 8
7	Digit 3, Bit 4	H	Digit 3, Bit 1
8	Digit 3, Bit 2	J	Digit 4, Bit 8
9	Digit 4, Bit 4	K	Digit 5, Bit 8
10	Digit 4, Bit 1	L	Digit 5, Bit 4
11	Digit 4, Bit 2	M	Digit 5, Bit 1
12	Digit 5, Bit 2	N	Digit 5 Disable
13	O.F. Bit	P	+ Bit (High = +)
14		R	Display Latch (High Latches)
15	+5 Volts In	S	DC Common

Upper Connector J-2			
Pin #	Function	Pin#	Function
1		A	Analog Common
2		B	Analog Out
3	Mode 1 On (F4)	C	DC Common
4	Reset to Zero	D	DC Common
5		E	
6	Z from Encoder	F	Z̄ from Encoder
7	B from Encoder	H	B̄ from Encoder
8	A from Encoder	J	Ā from Encoder
9		K	+5 Volts to Encoder
10		L	DC Common to Encoder
11	Direction (F3)	M	DC Common
12	A Quad B X1	N	DC Common
13	A Quad B X2	P	DC Common
14	Z On (F2)	R	DC Common
15	+5 Volts In	S	DC Common In

上海江晶翔电子有限公司

Dimensional Diagram - Shaft Coupler

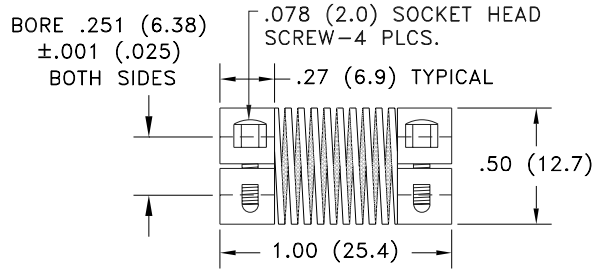

For applications with max. angular offset 5°, max. parallel offset .007 (.18), max. torque 71 ounce-inch (5130 g-cm)

All Dimensions in Inches (mm)

Dimensional Diagram - Power Supply

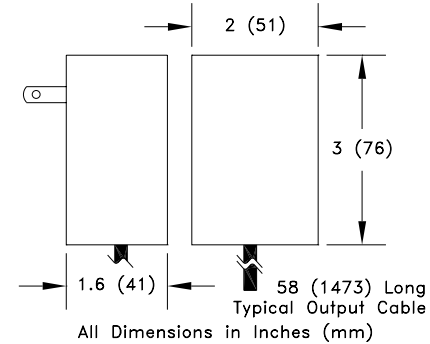

Accessories (Sold Separately)

F001-0019	Flexible Shaft Coupling - (see dimensional diagram above)
C003-0008	Connector - when ordered on Encoder, leads are terminated in type MS3106A-14S-5P connector (Red lead to Pin A; Orange to B; Black to C; Brown to D; Yellow to E)
C000-0046	Cable - vinyl jacketed, 15 ft. long*, terminated at one end in type MS3101A-14S-5S connector (mates with C003-0008) and leads at other end (Pin A to Red lead; B to Blue; C to Black; D to Brown; E to White; N/C to Green); operating temperature for Cable is -22°F to +176°F (-30°C to +80°C)
	Line Powered Supplies - output 5.0 VDC ±5% at current up to 0.5 Ampere (current to 2.5 A available at 5 VDC ±10%); 47-63 Hz input; operating temperature 32°F to 104°F (0°C to 40°C), storage temperature 32°F to 140°F (0°C to 60°C); with integral 2-prong North American line plug; terminated in bare ended output cable (only the end of + lead is tinned).
1100-0000	115 VAC Line Powered Supply - 95-130 VAC input (see dimensional diagram above)
1100-0001	230/115 VAC Line Powered Supply - 95-260 VAC input (see dimensional diagram above)

*Optionally available to 100 ft., but lengths longer than 25 ft. may limit Frequency Response; specify length if not 15 ft.